

Verbindungs- und Abschlussprofile für Stegdoppelplatten

Connecting and Edge Profiles for Twin-wall Sheets



Aus den meisten vorhandenen Werkzeugen können Sie gegen Abnahme einer Mindestmenge Profile aus anderen Materialien (PMMA, PMMA schlagzäh, PC, PS und ABS) beziehen.

Most of our tools can be used for the production of profiles in various materials (PMMA, high-impact PMMA, PC, PS and ABS) against the purchase of a minimum quantity. Please ask.

ESX 6/4

Eckverbindungsprofil aus PC für 6 und 4 mm Platten

Corner junction in PC for 6 and 4 mm sheets

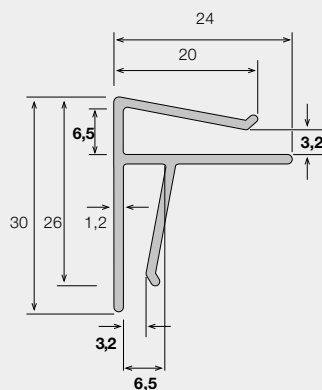

ESX 10/8

Eckverbindungsprofil aus PC für 10 und 8 mm Platten

Corner junction in PC for 10 and 8 mm sheets

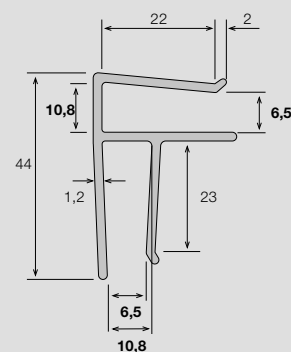

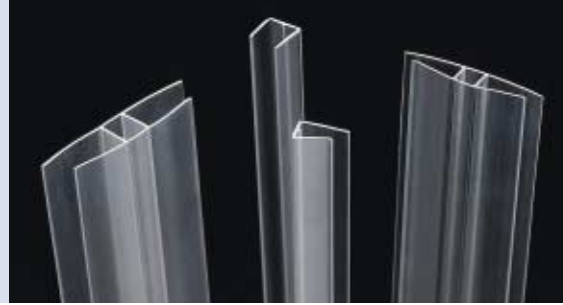

HSX 6/4

H-Profil aus PC für 6 und 4 mm Platten
H profile in PC for 6 and 4 mm sheets

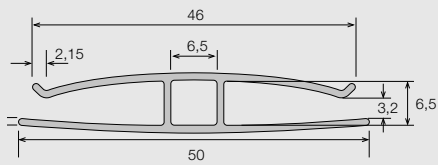

HSX 10/8

H-Profil aus PC für 10 und 8 mm Platten
H profile in PC for 10 and 8 mm sheets

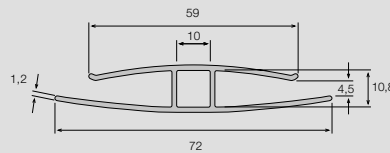

HSX 16

H-Profil aus PC für 16 mm Platten
H profile in PC for 16 mm sheets

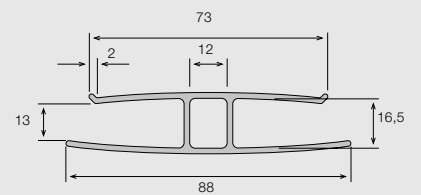

USX 6/4

U-Profil aus PC für 6 und 4 mm Platten
U-Profile in PC for 6 and 4 mm sheets

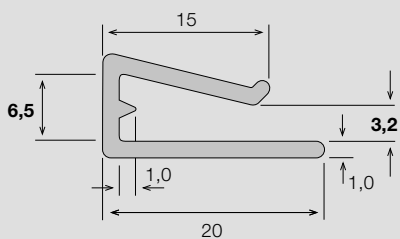

USX 10/8

U-Profil aus PC für 10 und 8 mm Platten
U-Profile in PC for 10 and 8 mm sheets

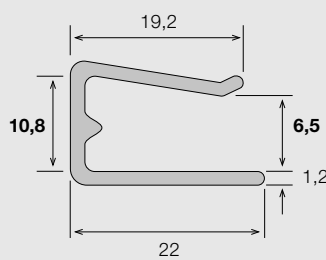

USX 16

U-Profil aus PC für 16 mm Platten
U-Profile in PC for 16 mm sheets

